



## Thermal RC network (Foster)

### SPICE thermal model

PSMN015-100YL

Symbol	Parameter	Conditions	Min	Typ	Max	Unit
$R_{th(j-mb)}$	thermal resistance from junction to mounting base		-	-	0.77	K/W

$C_{th1}$	6.162E-05 F
$C_{th2}$	4.070E-04 F
$C_{th3}$	4.396E-04 F
$C_{th4}$	3.634E-03 F
$C_{th5}$	6.243E-03 F
$C_{th6}$	1.557E-02 F
$C_{th7}$	1.939E-01 F
$R_{th1}$	1.359E-03 $\Omega$
$R_{th2}$	2.443E-03 $\Omega$
$R_{th3}$	1.954E-02 $\Omega$
$R_{th4}$	2.996E-02 $\Omega$
$R_{th5}$	1.383E-01 $\Omega$
$R_{th6}$	5.185E-01 $\Omega$
$R_{th7}$	6.149E-02 $\Omega$

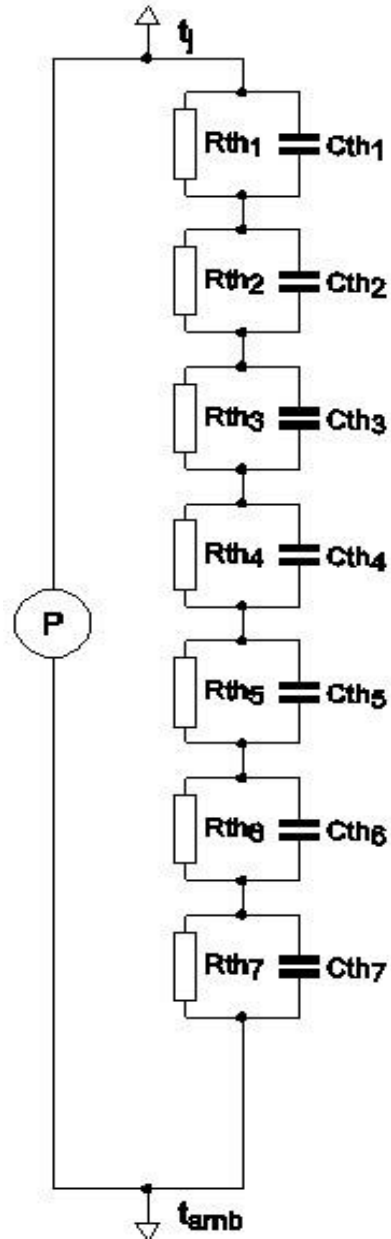

Part: PSMN015-100YL  
 Date: 2 / 3 / 2016  
 Rth 0.77 K/W

All rights reserved. Reproduction in whole or in part is prohibited without prior consent of the copyright owner. The information presented in this document does not form part of any quotation or contract, is believed to be accurate and reliable and may be changed without notice. No liability will be accepted by the publisher for any consequence of its use. Publication thereof does not convey or imply any license under patent- or other industrial or intellectual property rights.

Printed in the Netherlands